

FLAT SURFACE INSTALLATION

NARROW SURFACE MOUNT/ WIDE SURFACE MOUNT

1. Turn the lightbar upside down.
2. Insert the four (4) 5/16" mounting bolts into the channels on the underside of the lightbar.
3. Assemble the mounting assembly onto the lightbar as shown below but do not completely tighten the bolts. Leave them loose enough to reposition the mounting bracket.

▼ Narrow Surface Mounting Assembly

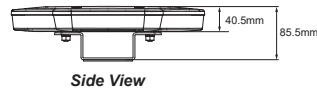
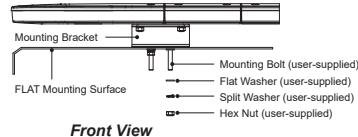
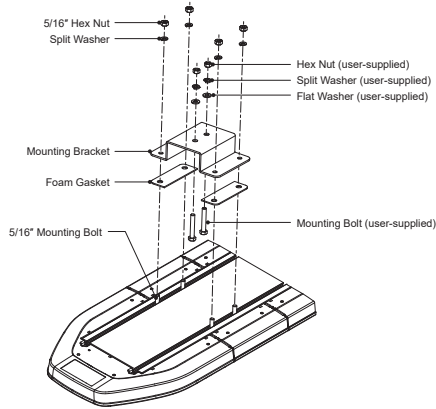

▼ Wide Surface Mounting Assembly

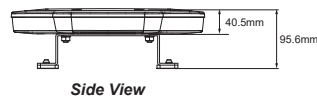
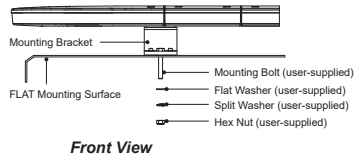
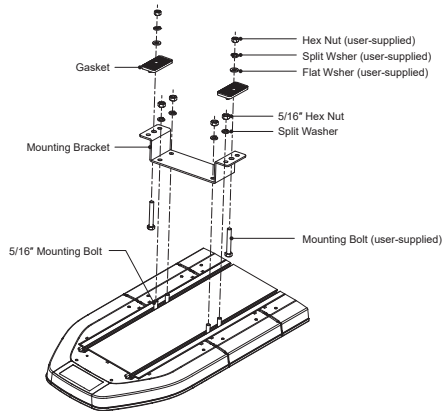

4. Place lightbar on the desired location and adjust both mounting bracket inward or outward as necessary. If possible, try to keep mounting bracket near the ends of the lightbar.
5. Using the mounting bracket as template and mark drilling holes on the mounting surface.
6. Remove the lightbar and drill the mounting holes as marked.
7. Tighten the nuts that secure the mounting bracket to the lightbar.

NOTE: Set driver torque force at 30~40 kgf-cm.

8. Place lightbar on the surface and align the mounting holes with the mounting bracket. Secure mounting bracket on to the surface with bolts and nuts (user-supplied).
9. Apply silicone sealant around mounting holes (wherever necessary) to prevent possible water leakage.

NOTE: After installation, frequently inspect the lightbar and mounting feet to ensure that all nuts and bolts are firmly secured.

Raiden Lightbar Installation Manual

CONTENTS

Pre-Installation	1
Vehicle Roof Installation	2
Standard Feet	2
Permanent Mount	2
Strap Kit Mount	3
Rubber Feet Installation	3
Flat Surface Installation	4
Narrow Surface Mount / Wide Surface Mount	4

PRE-INSTALLATION

To prevent damage to lightbar and vehicle, ensure that all equipment operates properly, and carefully plan where to mount and wire the lightbar and controlling equipment:

1. Verify that the lightbar and mounting hardware fit the vehicle.
2. Pre-configure desired lightbar functions (e.g. flash pattern)
3. Determine:
 - the location to mount the lightbar.
 - the location to route the lightbar's power/function cable.

WARNING: Take extreme care when routing wires around airbag areas to not interfere with it's proper operation.

4. Separate all electronic equipment wiring from two-way radio equipment wiring.
5. To avoid interference, keep two-way radio antennas a minimum of 50cm away from warning equipment.
6. Before drilling holes in ANY part of the vehicles, ensure that both sides of the mounting surface are clear of parts that could be damaged, such as brake lines, fuel lines, electrical wiring, or other vital parts.
7. After drilling holes, deburr and smooth sharp edges, and insert grommets to protect the wires from chafing.
8. When frame-ground the equipment, use the manufacturer-supplied ground locations in the vehicle.

⚠ WARNING

■ **DO NOT USE A HIGH PRESSURE POWER WASHER TO CLEAN YOUR LIGHTBAR; THIS MAY DAMAGE YOUR LIGHTBAR AND VOID ITS WARRANTY.**

VEHICLE ROOF INSTALLATION

STANDARD FEET- Install Mounting Feet on the Lightbar

1. Turn the lightbar upside down.
2. Insert the eight (8) 5/16" mounting bolts into the channels on the underside of the lightbar. Four (4) for each side.
3. Assemble the mounting foot onto the lightbar as shown below but do not completely tighten the bolts. Leave them loose enough to reposition the mounting foot.

NOTE: Set driver torque force at 30~40 kgf-cm.

▼ Standard Feet with Standard Gasket

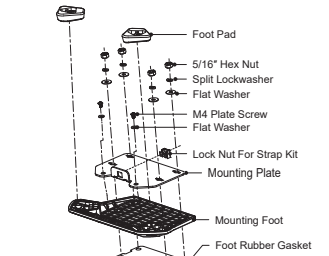

Mounting Assembly



Side View

▼ Standard Feet with 2° Angled Gasket

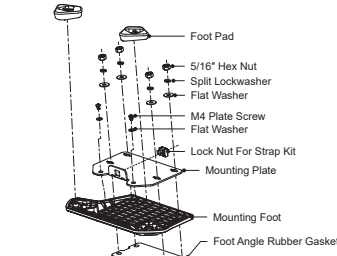

Mounting Assembly

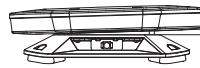

Side View

▼ Standard Feet with two 2° Angled Gasket

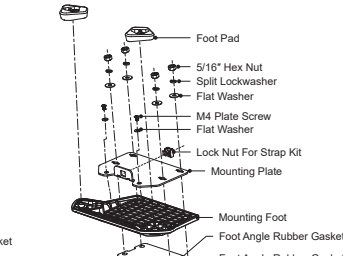

Mounting Assembly

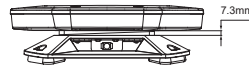

Side View

PERMANENT MOUNT- Install the Lightbar on the Vehicle Roof

1. Place lightbar on the vehicle roof at the desired location. The lightbar is usually centred on the door center post (B-pillar).
2. Adjust both mounting feet inward or outward as necessary until the footpads rest near the edge of the roof or gutter (where the roof is the most rigid).
3. Level the lightbar by shifting the lightbar slightly forward or backward.
4. Using the mounting feet as a template, mark two drilling holes on each side of the vehicle roof.
5. Remove the lightbar and drill the mounting holes as marked.

WARNING: DO NOT DRILL THROUGH the roof support structure that spans the distance between the driver's and passenger's side. Drilling through this will weaken the roof of the vehicle.

6. Tighten the bolts that secure the mounting feet to the lightbar.
7. Place lightbar on the vehicle roof and align the mounting holes with the mounting feet. Secure mounting feet to the vehicle roof with carriage bolts and nuts (user-supplied).
9. Apply silicone sealant around mounting holes (wherever necessary) to prevent possible water leakage.

NOTE: Set driver torque force at 30~40 kgf-cm.

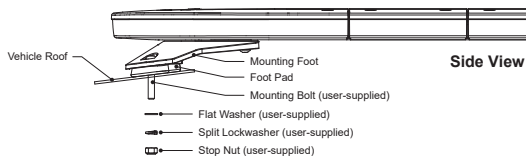

Side View

NOTE: After installation, frequently inspect the lightbar and mounting feet to ensure that all fasteners are tight.

STRAP KIT MOUNT- Install the Lightbar on the Vehicle Roof

The Strap Kit is designed for specific vehicle model. Before installation, ensure that the correct strap kit is used.

1. Place the lightbar on the vehicle roof at the desired location. Usually, the lightbar should be centered on the center door post (B-pillar).

NOTE: Water may leak into the vehicle interior if the straps are improperly installed. Ensure that the straps are positioned above or near the center door post (B-pillar).

2. Determine where the straps will attach to the vehicle.

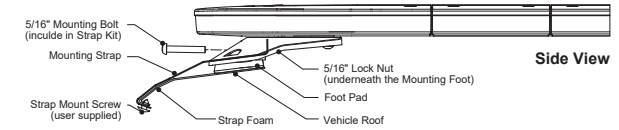

Side View

3. Place the strap in the position on the roof as shown in the diagram.
4. Using the mounting strap as template and mark drilling holes on the vehicle.
5. Remove the lightbar and drill the mounting holes as marked.
6. Apply silicone sealant around the holes before attaching the straps.
7. Secure the straps to the vehicle with screws (user supplied).
8. Place the lightbar on to the vehicle roof and align the strap bolt holes with lock nuts.
9. Insert the bolt through the strap hole to the lock nut.
10. Secure the bolt firmly; repeat steps for the other side; ensure that the lightbar is centered on the roof.

NOTE: Set driver torque force at 30~40 kgf-cm.

RUBBER FEET MOUNT

1. Place lightbar with rubber feet on the vehicle roof at the desired location.
2. Carefully remove the lightbar from the vehicle roof.
3. Using rubber foot as template and mark drilling holes on the vehicle roof.
4. Remove the lightbar and drill the mounting holes as marked.

WARNING: Do not drill through the roof support structure that spans the distance between the driver's and passenger's side. Drilling through this will weaken the roof of the vehicle.

5. Insert the four (4) M8 mounting bolts into the channels on the underside of the lightbar.
6. Secure the lightbar on the vehicle roof with rubber feet and provided hardware as shown below.

NOTE: Set driver torque force at 30~40 kgf-cm.

▼ Rubber Feet Mounting Assembly

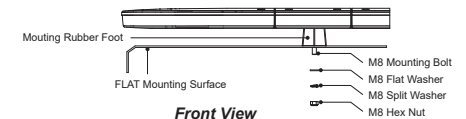
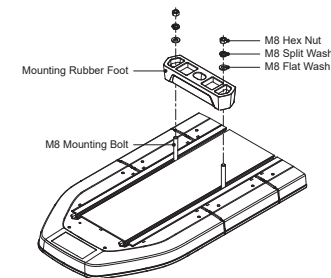

Front View



Side View